

# ULTRACOMBI

Tri-mode oven

hot air - steam - microwave



**INSTALLATION,  
USER AND MAINTENANCE INSTRUCTIONS**

# INDEX

---

## **3 IMPORTANT SAFETY WARNINGS**

## **13 ELECTRICAL CONNECTIONS**

## **15 INSTALLATION INSTRUCTIONS**

## **16 PRODUCT DESCRIPTION**

17 Supplied Accessories

19 Cooking Accessories

## **21 INSTRUCTIONS FOR USE**

21 Display TFT:

21 Icon legend

22 First start of the oven

23 Settings

24 Screen lock

25 Turning the oven on and off

26 Setting the cooking function

27 Functions list

28 Setting the cooking function

29 Cooking process

30 Cooking function setting

31 Cookware / Material

32 Steam cooking

## **33 CLEANING - CARE - MAINTENANCE**

34 Cleaning

38 Emptying and Washing the tank

## **39 PROBLEM SOLVING**

39 Error messages

# IMPORTANT SAFETY WARNINGS



---

**Appliances' data** As well as being shown on the cover, the data plate is applied to the oven door frame and is visible with the door open.

---

## CAUTION

These warnings refer to different types of appliances. Pay attention in properly identifying the type you own (see the data plate).

---

These warnings are valid for the countries mentioned in the plate.

---

- 1** Before using the cooker, read carefully the following instructions and keep in a safe place for future reference. This multifunction oven complies with current statutory safety standards. Inappropriate use can, however, lead to personal injury and material damage. I.L.V.E. SpA cannot be held liable for any damages caused by failure to observe these instructions for safety and warnings.
- 

## INTENDED USE

- 2** NOTE: This oven has been designed to defrost, reheat and cook foodstuff in domestic households and residential environments. The multifunction oven is intended exclusively for residential use and must always be operated for its intended purpose: it must not be modified or tampered with in any way. Any other usage is not allowed and could be dangerous. It is not intended for use outdoors.

Persons who lack physical, sensory or mental abilities or experience with the multifunction appliance, so that they cannot safely operate it, should not use it without supervision or instruction by a responsible person.

It is important that they recognise and understand the dangerous consequences of incorrect operation of the appliance.



---

### 3 PRECAUTIONS TO AVOID POSSIBLE EXPOSURE TO EXCESSIVE MICROWAVE ENERGY

Do not attempt to operate this oven with the door open since open-door operation can result in harmful exposure to microwave energy. It is important not to damage or tamper with the safety interlocks

Do not place any object between the oven front and the door or allow soil or cleaner residue to accumulate on the sealing surfaces.

---



- 4 **WARNING:** Do not operate the oven if it is damaged. It is particularly important that the oven door closes properly and that there is no damage to the (1) door (bent), (2) hinges and latches (broken or loosened), (3) door seals and sealing surfaces. If the door and the sealing gaskets are damaged, the oven shall not be used until repaired by a properly qualified service technician ( trained by the manufacturer or by the Customer Service ).
- 



- 5 **WARNING:** It is dangerous for anyone without suitable training to perform maintenance and repair operations requiring removal of any casing or barrier against exposure to microwaves. During installation, maintenance and repair work, the appliance must be disconnected from the mains electricity supply. Never open the casing of the appliance. Tampering with electrical connections or components and mechanical parts is highly dangerous to the user and can cause operational faults.
- 



- 6 **ATTENTION:** Do not heat liquids or other foods in sealed containers, jars or bottles because they could explode.
- 

- 7 This appliance must be used only in a domestic household. The mains supply must be fitted with all devices required

## IMPORTANT SAFETY WARNINGS



by the statutory rules of installation.

---

- 8** When the oven is operated in microwave mode it is intended to heat food and drinks. Do not use the microwave mode for drying flowers, herbs, bread, rolls or other flammable materials like sponges, slippers, cushions or pads filled with cherry kernels, wheat grain, lavender or gel, such as those used in aromatherapy. When heated, these pads could catch fire and cause injury by burning even after they have been removed from the oven.
- 



- 9** If smoke is observed do not open the oven door: switch the appliance off and disconnect it from the mains electricity supply. Do not open the door until the smoke has dispersed to stifle any flames.
- 

### CHILDREN

- 10** - Activate the system lock to ensure that children cannot switch on the multifunction oven inadvertently  
- Supervise the children if they are in close vicinity to the multifunction oven. Do not allow them to play with the appliance.



#### **-Danger of suffocation.**

Packaging, e.g. plastic wrappings, must be kept out of the reach of babies and children. Whilst playing, children could become entangled in packaging or pull it over their head and suffocate. Keep children away from this kind of materials.



#### **-Danger of burning.**

Children's skin is far more sensitive to high temperatures than that of adults. The door surface, the control panel and the ventilation openings get hot. Make sure that children do not attempt to open the door when the appliance is in operation. Keep children well away from the appliance until it has cooled down and there is no danger of burning.

# IMPORTANT SAFETY WARNINGS



## **Danger of injury.**

The door can support a maximum weight of 8 kg. Do not let children sit on the door, lean against it or swing on it. They could injure themselves



**ATTENTION.** Accessible parts may get very hot during operation.

Children under 8 years of age must be kept away from the appliance unless they are constantly supervised.

The appliance may be used by children 8 years and older and by persons who lack physical, sensory or mental abilities or experience with the multifunction appliance , with supervision or instruction by a responsible person. It is important that they recognise and understand the dangerous consequences of incorrect operation of the appliance. Children must not play with the appliance. Children must not be allowed to clean the oven unsupervised



---

**11 ATTENTION:** when the appliance is operated in combination mode children should use it under adult supervision, because of the high temperatures that will develop.

---

**12** Do not attempt to operate the oven with the door open, tampering with the safety interlock switches. Do not operate the oven if any kind of objects get trapped between the door and the oven front plate. Always keep the inner side of the door clean(J) using a damp cloth and non abrasive cleaners. Don't let food residues accumulate between the mating surfaces of the door and the oven front plate.

---



**13** Do not operate the oven if the mains supply cable or the plug are damaged, because this could cause an electric shock. If the mains supply cable is damaged, it must be replaced by the manufacturer's customer service or by a qualified person, in order to avoid any risk.

## IMPORTANT SAFETY WARNINGS



- 
- 14** To avoid overheating and the following risk of a fire, it is recommended to attend the oven when cooking food-stuff in disposable containers made of plastic, cardboard or other flammable material, or when small quantities of food are reheated
- 
- 15** Do not put very cold dishes or food directly onto the inner door glass when it is hot: the thermal shock could make it crack.
- 
- 16** When the oven is operated in “Microwave only” mode, it must not be preheated without a food load inside the cavity, nor shall it be turned on empty, because arcing could be generated.
- 
- 17** Before starting the oven, make sure that the utensils and containers are suited for microwave operation ( see the relevant page: “Containers for different cooking modes”).
- 
- 18** The appliance gets hot during use. Do not touch the heating elements inside the oven cavity.
- 
-  **19** When reheating liquids ( water, coffee, milk , etc.) it is possible that, due to “delayed boiling”, the liquid reaches a temperature higher than the boiling point, so that – when removing the container- it can form eruptive bubbles and cause injuries to the user. To avoid this, always place a glass or plastic utensil ( e.g. a spoon) into the cup or container. Care should be taken when handling the container.
- 
- 20** Do not reheat liquors or spirits, nor big quantities of oil, because they could catch fire.
- 
- 21** After reheating baby milk or food ( in bottles or jars) shake or stir thoroughly and check the temperature to avoid scalding. The temperature of the container is not an in-



# IMPORTANT SAFETY WARNINGS



dication of the temperature of the food or liquid in it. It is recommended to stir and shake the food also in order to ensure a uniform temperature. When using commercially available baby bottle sterilisers, **always** check that the containers are filled with the correct quantity of water indicated by the manufacturer.

---



**22** Do not use steam cleaners to clean the inside of the appliance.

---



**23** Do not use abrasive cleaners or sharp metal tools to clean the door glass. They could scratch the glass surface and result in cracking it.

---



**24** All microwave ovens are tested and certified in compliance with the latest safety and electromagnetic compatibility standards . However, as a precaution, manufacturers of pace-maker devices recommend to keep a minimum distance of 20- 30 cm between an operating microwave oven and the pace-maker, in order to avoid any interference to the pace-maker device. If for any reason there should be a suspect of interference, immediately switch the microwave operation off and contact the manufacturer of the pace-maker.

---

**25** In case of overheating of the appliance ( prolonged use, use without load, etc.) the oven could be switched off by a safety thermostat. After cooling down the oven will resume its regular operation.

---

**26** When the appliance is operating, the door and the accessible surfaces may become hot.



## IMPORTANT SAFETY WARNINGS



- 
- 27** Do not cook or reheat eggs in their shells using microwave power, because they could explode even after the cooking has ended.

- 
- 28** For safety reasons, this multifunction oven may only be used when it has been built in. This is necessary to ensure that all electrical components are shielded.



- 
- 29** This multifunction oven must not be used in a non-stationary location (e.g. on a ship).

Oils and grease could easily catch fire if overheated. Always supervise the appliance when using oils and grease. Never attempt to extinguish with water burning oils and grease. Switch off the appliance and stifle the flames carefully using a lid or with a special fire-safe blanket. Flammable objects situated in the vicinity of the oven may start burning if exposed to high temperatures. Do not use the appliance to heat the ambient.

- 
- 30** Plastic cutlery or dishes not suited for microwave energy could melt due to the high temperatures reached, and may burn and damage the oven. Only use dishes suited for use with microwave power. Follow the directions provided by the manufacturer: when using plastic dishes inside the oven, please make sure that they resist to heat and steam. If they are not, they could melt or be damaged.

- 
- 31** Be aware that cooking, reheating and defrosting times when using microwave power are often considerably shorter than when using conventional functions. Too long heating times lead to food desiccation and a possible combustion.

# IMPORTANT SAFETY WARNINGS



- Cleaning
- 32**
- The appliance must be cleaned regularly and any food residues must be removed. Failing to clean the oven may cause deterioration of the surfaces. This can have a negative effect on the durability of the appliance and cause possible risk situations. Clean the oven interior, inside of the door and door seal as soon as the oven has cooled down.
  - Clean the front of the appliance and the door sealing surfaces with a soft cloth with warm water and a cleaning agent.
  - To clean metal surfaces, use a usual cleaning agent.
  - Clean stubborn dirt with a special oven cleaner.
  - Clean all accessories after each use and let them dry. Use a soft cloth with warm water and a cleaning agent.

Lamp

**33 WARNING!**

**Before you change the lamp:**

Ensure the appliance is switched off before replacing the lamp to avoid the possibility of electric shock.

**CAUTION:** The lamp and the lamp glass cover can be hot. Put a soft cloth on the bottom of the interior of the appliance. It prevents damage to the lamp glass cover and the cavity. Always use the same lamp type.



**Replacing the lamp**

Turn the lamp glass cover counterclockwise to remove it.

- Clean the glass cover.
- Replace the lamp with a suitable 25W Halogen lamp.
- Re-install the glass cover.

During installation, maintenance and repair work, the appliance must be disconnected from the mains electricity supply



---

## 34 Steam cooking

Do not operate the oven if the glass lamp cover has been removed. Steam could reach electrically live parts and cause a short-circuit; also electrical components could get damaged.

If the multifunction oven is installed behind a furniture panel (e.g. a door), ensure that the door is never closed whilst the appliance is in use. Heat and moisture can build up behind a closed furniture panel and cause subsequent damage to the multifunction oven, the housing unit and the floor. Do not close the door until the appliance has cooled down completely.



---

## 35 **WARNING!** Danger of burning.

-The multifunction oven becomes hot when in use. You could burn yourself on the heating elements, oven interior, cooked food, oven accessories or hot steam. Wear oven gloves when placing food in the oven or removing it and when adjusting oven shelves etc. in a hot oven. Take care when putting cooking containers into the oven or removing them not to spill the contents.

-Do not open the oven door during steam cooking. Hot steam may come out, there is a risk of getting burnt or to damage the appliance.

- Never line the interior of the oven cavity with e.g. foil or film. Do not put containers, pans and pots directly on the bottom of the cavity.

## DISPOSAL OF THE PACKAGING MATERIAL



The packaging is intended to protect the appliance from damage during transportation.

The packaging materials are easily recyclable because they have been selected according to environmental friendly criteria.

Recycling them reduces the need for raw materials and reduces the volume of waste.

Electrical and electronic appliances often contain valuable materials. They also contain materials which, if handled or disposed of incorrectly, could be potentially hazardous to human health and to the environment. They are, however, essential for the correct functioning of your appliance. Please do not therefore dispose of it with your household waste.

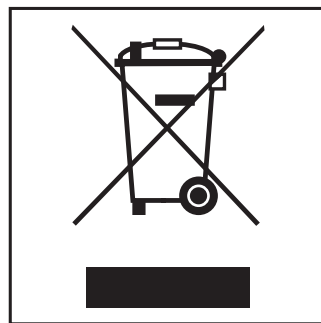

Please dispose of it at your local community waste collection / recycling centre or contact your Dealer for advice.

Ensure that it presents no danger to children while being stored for disposal.

# ELECTRICAL CONNECTIONS

---

## ATTENTION



The instructions below are intended for the skilled technician who will install the appliance, regulate it and perform technical maintenance and who will ensure that these operations are carried out in the most correct way possible, in compliance with the regulations in force.

**Important: the appliance must be disconnected from the electric socket before performing all regulating or maintenance operations.**

---

## Rules for installation

- Installation must be carried out in a workmanlike manner, fully complying with the legislation in force regarding electrical installations. Otherwise, the manufacturer disclaims any responsibility. You will find your appliance's wiring diagram in this booklet.

- The appliances are prepared for connection to the voltage shown on the data plate.

- **Before connecting the appliance to the mains check that:**

- the electromagnetic switch or the socket are able to support the appliance's load (see dataplate);

- the power supply system must have an efficient grounding system.

---

## ATTENTION



The appliance is supplied with a cable but without a plug: the connection must be made taking into account that the green-yellow cable is the ground conductor (⊥) and it must never be interrupted. The socket must be visible and easily reachable so that the appliance can easily be disconnected. For direct connection to the mains, it is necessary that:

- the relief valve and domestic system can support the equipment's load (see data plate)

## ELECTRICAL CONNECTIONS

- the socket or omnipolar switch, with a minimum 3 mm contact opening, must be easily reachable once the appliance has been installed.
- means for disconnection must be incorporated in the fixed wiring in accordance with the wiring rules

### ATTENTION



The yellow-green ground wire must never be interrupted even by the switch. The power cable should be positioned so that it does not come into contact with surfaces that have a temperature of 50 °C higher than the environment. In case replacement of the power cable is necessary, contact the customer service.

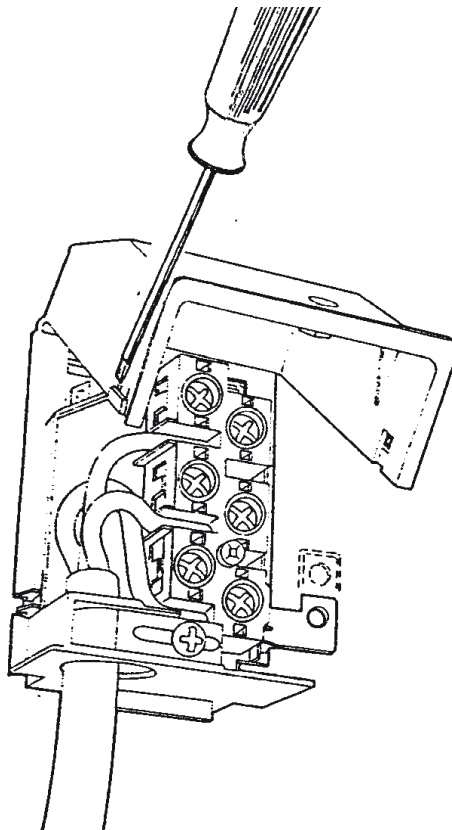

# INSTALLATION INSTRUCTIONS

## Oven data

The serial plate is positioned on one side of the front plate of the oven, and is visible opening the door; it shows all data necessary for the installation, e.g. model number nominal voltage and power input.

## Important points

First check the dimensions of the furniture opening; they must be exactly equal to those shown in the picture. Make sure that the laminated surfaces or veneered panels be manufactured using heat-resistant glue. If they are not, they could get warped or detach especially in the narrowest parts of the furniture. Also check that the floor of the built-in niche must be solid and able to carry the weight of the appliance.

All screws and bits needed to fasten the oven in the furniture are supplied with the product.

All dimensions are indicated in mm.

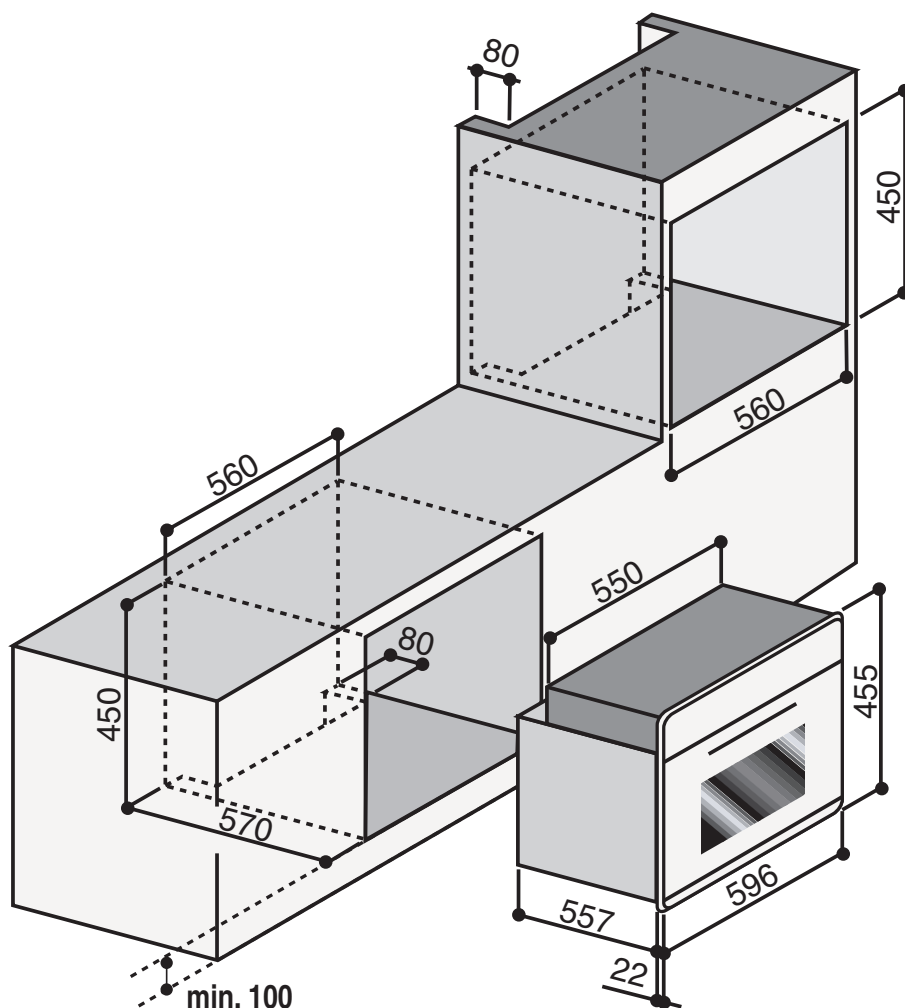



# PRODUCT DESCRIPTION

---

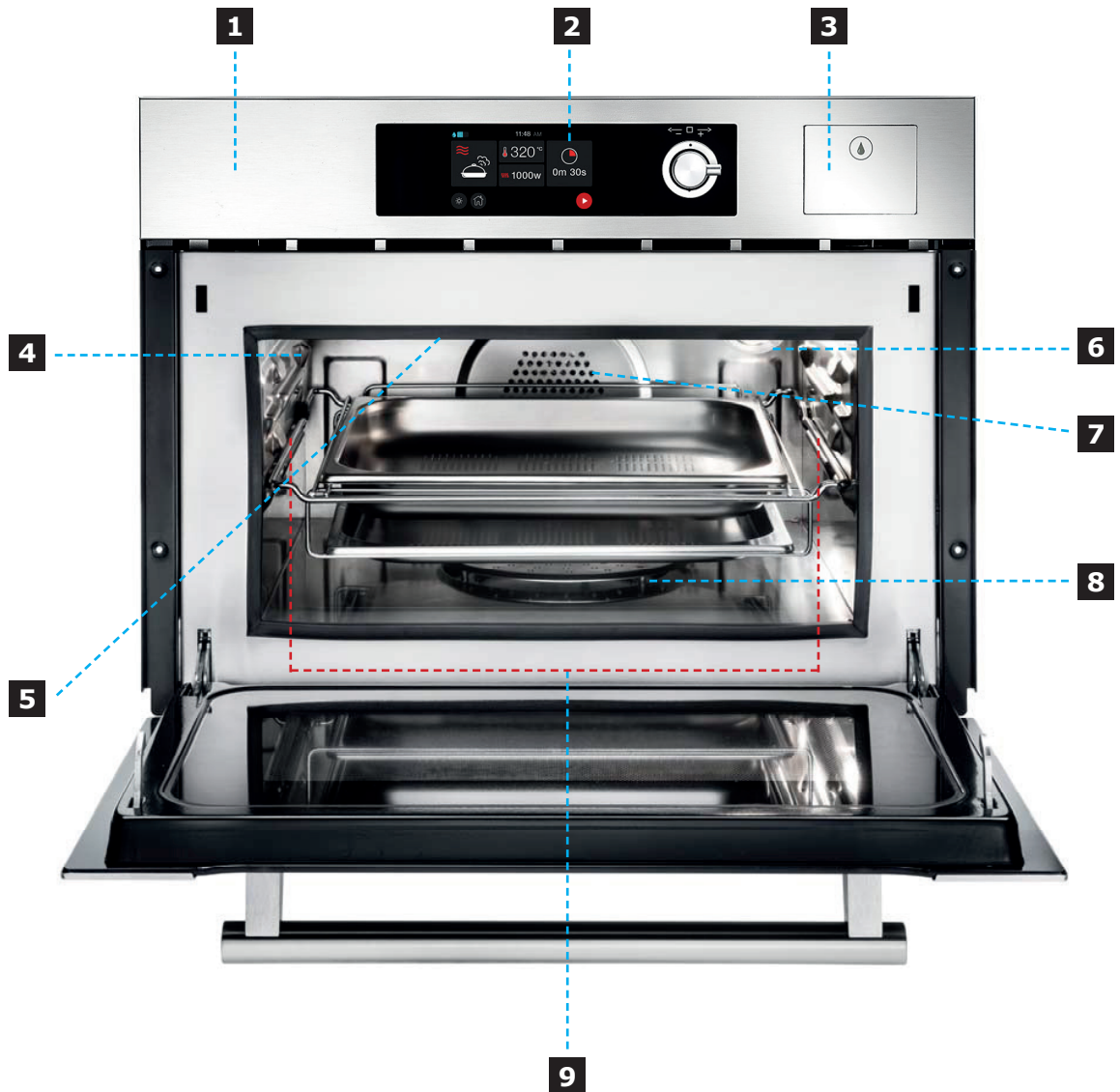

- 1** Control panel
- 2** TFT touch Display
- 3** Drawer for water load
- 4** Food probe socket
- 5** Grill heater
- 6** Oven lamp
- 7** Convection heater and fan
- 8** Boiler with lid
- 9** Rack supports

## PRODUCT DESCRIPTION

### - Supplied accessories

---



#### Wire rack

For cookware, trays and roasting

---



#### Pyrex glass tray

For microwave cooking and drip pan use

---



#### Steam cooking set

Wire frame supporting 2 dedicated trays:



- perforated tray, allows steam to reach the food completely



- shallow tray, to collect condensation water dripping down

## PRODUCT DESCRIPTION

### - Supplied accessories

---



---

#### Food probe

To reheat and cook food selecting core temperature

---



---

#### Jug

To fill the water tank for steam cooking and to collect the water when emptying the tank

---



---

#### Silicon pipe

To be used with the jug when emptying the tank

---

# PRODUCT DESCRIPTION

## - Cooking Accessories



### Baking tray (if applicable):

Insert the baking tray in the wire frame as shown.



Lift the outer part of the frame and push it into the cavity to slide beyond the corner.



**NOTE:** the barrier indicated by the red arrow must be oriented upwards and shows the back side of the frame.



Frame with baking trays fully inserted



# PRODUCT DESCRIPTION

## - Cooking Accessories



### Pyrex glass tray

When using the glass tray put it on the upper part of the frame (the lower tray is not necessary). Insert the frame as seen before

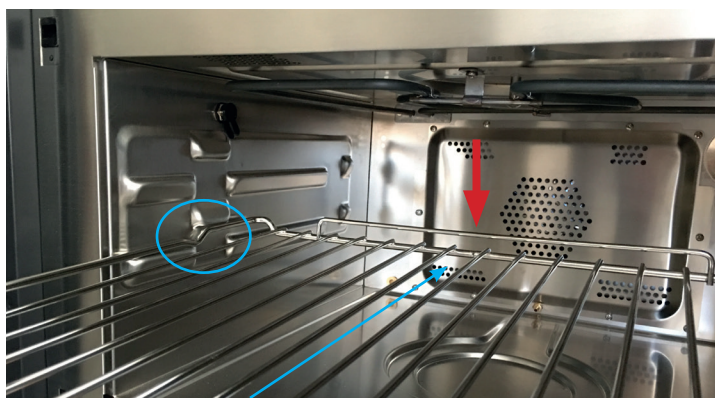

### Wire rack

Lift the outer part of the rack and push it into the cavity to slide beyond the corner. Select the desired level suitable for the cooking function

**NOTE:** the barrier indicated by the red arrow-must be oriented upwards and shows the back side of the rack.

# INSTRUCTIONS FOR USE

## - Display TFT touch

### - Icon legend



Pause



Start



°C - °F



Screen lock



Confirm and go to next step



Settings



Meat probe



Knob present in some models.  
(It allows to set and confirm the functions of the TFT in addition to the Touch display)



Home



Light



Timer



Exit - Terminate



Clock



Setting confirmation

# INSTRUCTIONS FOR USE

## – First start of the oven

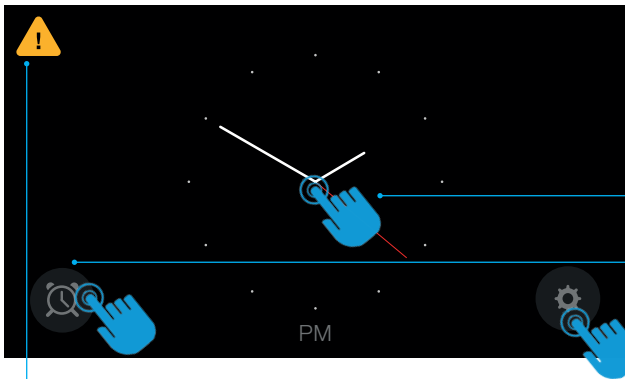

Home: display homepage.

3 options

Allows you to proceed to the screen setting of the cavity

Allows you to set the timer

Gives you direct access to the settings

Warning at first power - on: washing cycle required  
(does not prevent operation if not performed)\*

### NOTE:

The yellow triangle will disappear:

**A** - if the tank is filled with some water and completely emptied. Open the door and touch the triangle to start

\* (If the washing / emptying operation is not performed, the oven will operate regularly but when switched off the yellow triangle will remain visible).

**B** - With reference to the picture below, that appears touching the yellow triangle opening the door, by pushing the



(the triangle will reappear after the power has been shut off)





# INSTRUCTIONS FOR USE

## – Settings

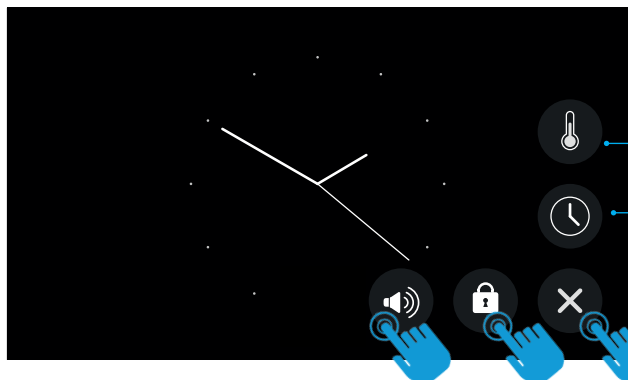

### Settings

Choice of degree scale (°C or °F).

Time settings.

Exit the settings page.

Screen lock

Allows you to set the volume of the beep and choose a sound when touching the display

### Setting a timer

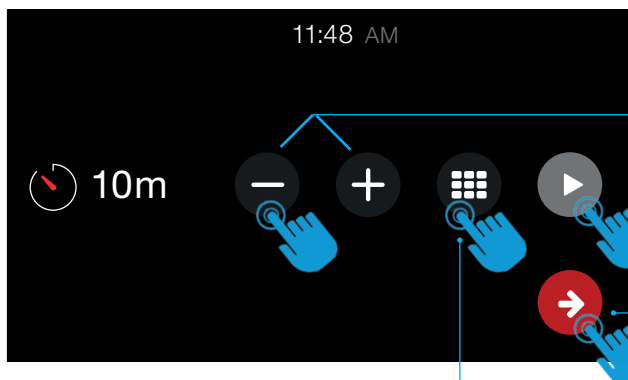

Increase or decrease the time.

Confirm once you have set the desired time. An audible signal will indicate the end.

Confirm and return to the home page.

Numeric keyboard

# INSTRUCTIONS FOR USE

## – Display TFT touch: Screen lock

### Turn on screen lock

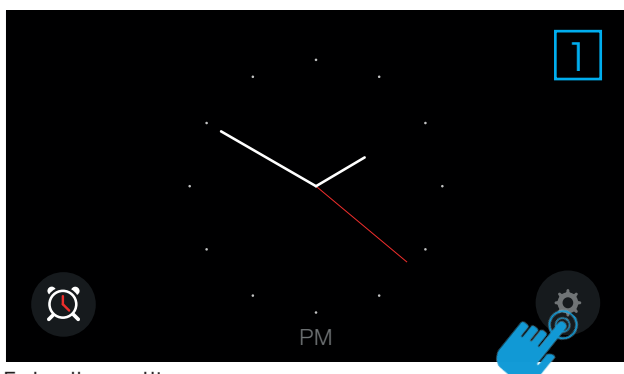

Enter the settings

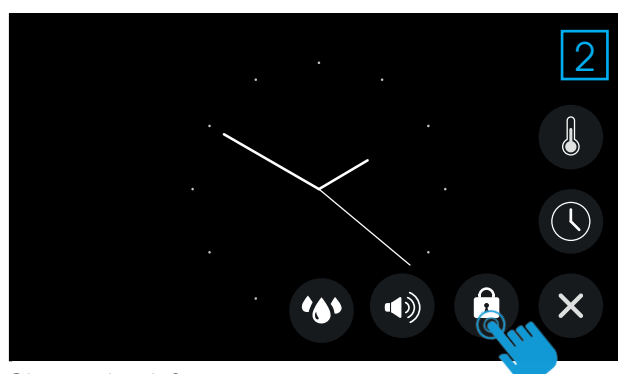

Choose Lock Screen

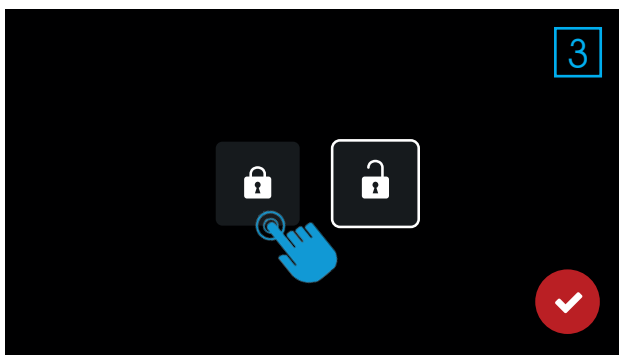

- Choose closed Lock
- Confirm

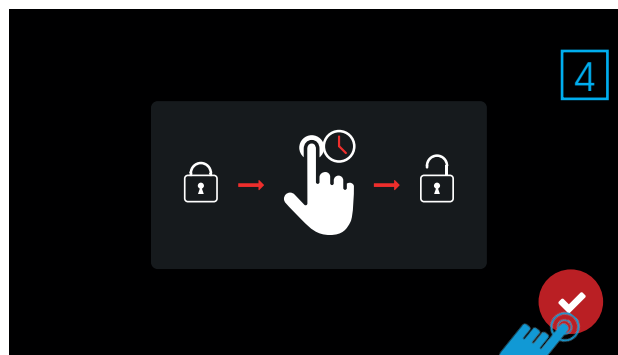

Give confirmation

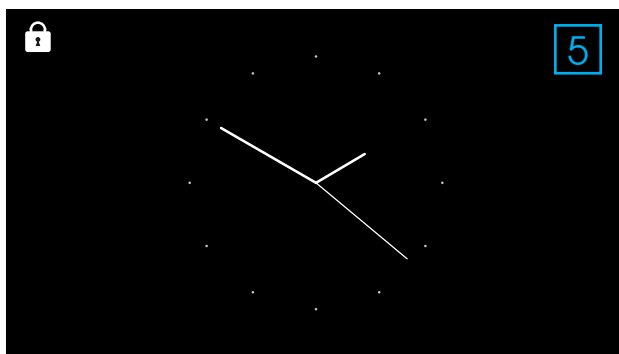

Locked screen

### Turn off Screen lock

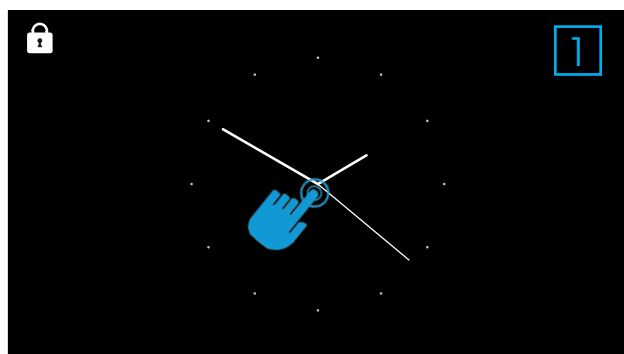

Turn off Screen lock

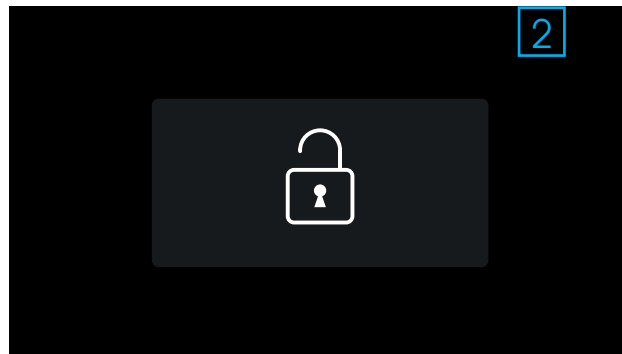

# INSTRUCTIONS FOR USE

## – Turning the oven on and off

### QUICK START ON/FUNCTION

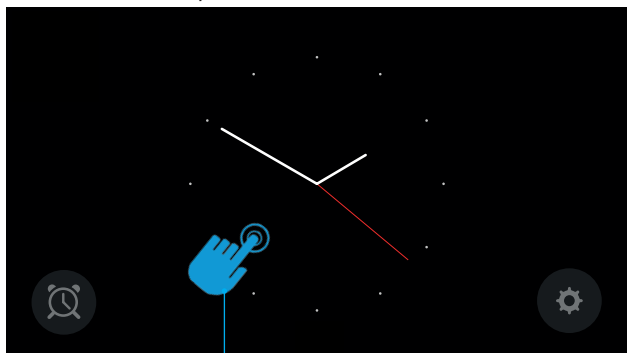

By touching any point of the TFT display the oven is turned on (ON state) showing this display and emitting 3 acoustic signals. Immediately the microwave function is activated.

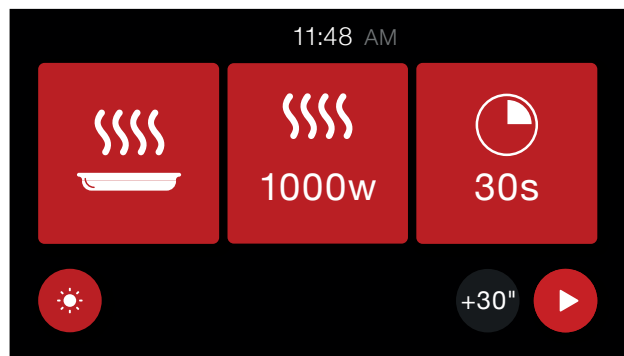
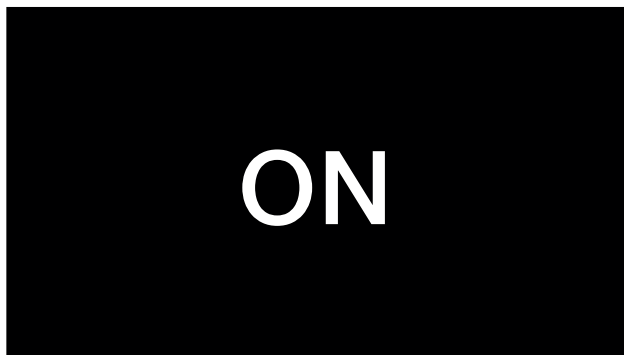

The microwave function is activated with a default setting of 30s at full power (1000W). This is useful, for example, to reheat a cup of coffee. By pushing the start button the oven will start. It is possible to increase the heating time in 30" steps pushing 

### COOKING END/OFF

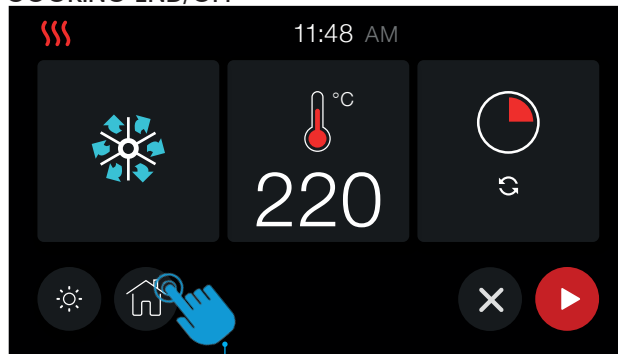

At the end of any cooking process it is possible to go back to the initial home page pushing the HOME button. A long signal is emitted the display shows the OFF state.

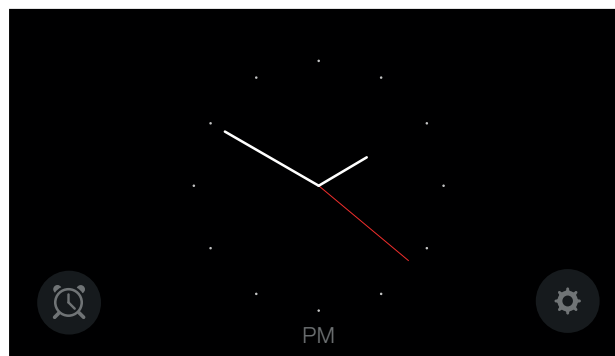
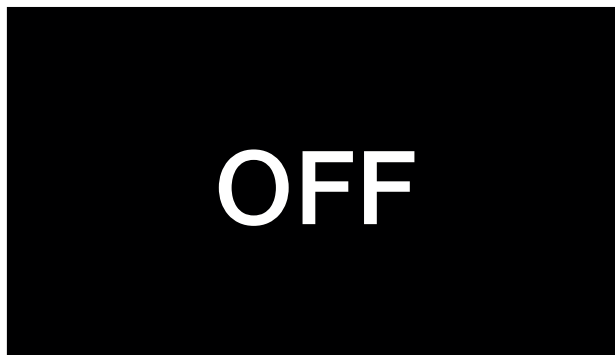

Immediately after the display will show again the time of day clock. It is possible to turn the oven on again following the previous procedure (QUICK START/ON)

 Be sure to put some food or liquid into the oven cavity before starting the microwave: The oven can suffer damage when using microwave energy if it is empty or incorrectly loaded. For this reason please do not use the microwave function when the oven is empty.

# INSTRUCTIONS FOR USE

## – Cooking functions

After turning the oven on, if another function is desired, touching the microwave icon the full selection of the available cooking modes will appear. Choose the function touching the relevant icon.

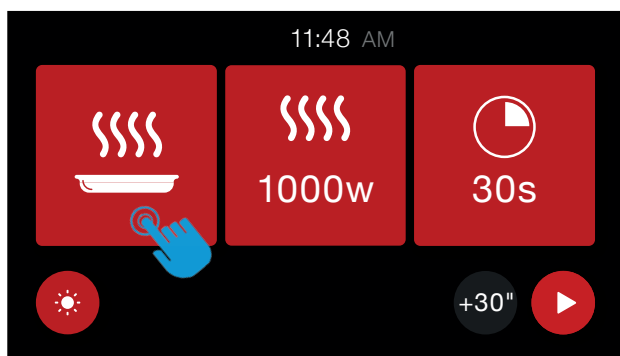

The white frame shows the last operating mode

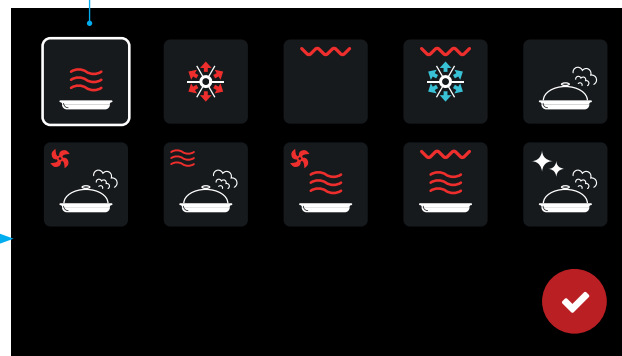

# INSTRUCTIONS FOR USE

## – Functions list

---



### **Microwave**

This function is especially suited for quickly reheating and defrosting food and ready meals. It is also possible to cook vegetables, fish, some cakes; moreover it is useful for softening butter, melting chocolate and defrosting delicate cakes.



### **Hot air (forced convection)**

This function allows to cook at the same time on different levels various dishes without mixing the relevant smells; useful for lasagna, pizza, croissants, brioches, cakes, pies, etc.



### **Grill ( with door closed)**

This function is indicated for quick and deep grilling, ideal to broil and cook meat in general, fillets, T-bone steaks, fish and also vegetables. Thin foods and bread for toast shall be positioned on the central area of the grill rack, and in general the thermostat shall be set at 180°C.



### **Vented Grill**

Particularly quick and deep cooking with significant energy savings, this function is indicated for pork chops, sausages, pork or mixed skewers, game, gnocchi gratin, etc. Also in this case the thermostat should be set at 180°C.



### **Steam**

This function allows to recondition sous-vide dishes at low temperature, keeping the original colours and the uniform smooth texture. Best for cooking vegetables, fish and delicate food items.



### **Combination steam + convection**

Good for cooking in the oven with the advantages of steam. This function allows to reduce the cooking time while maintaining the vitamins and nutritional properties of food. Best results setting the oven temperature between 130° and 230°C.



### **Combination steam + microwave**

This function allows to combine the advantages of steam cooking with the speed of microwaves; it is particularly suited for rice, vegetables, flans, minced meat, mashed potatoes.



### **Combination convection + microwave**

This function is most indicated for cooking roast pork and chicken quickly but without drying out the food in the end. Time saving can reach 40-50%.



### **Combination grill + microwave**

This function is most indicated for cooking in a short time “family meal” quantities of gratin dishes (e.g. potatoes and cheese), baked pasta, vegetables with tough texture.



### **Steam cleaning**

This program is specifically intended to be used for softening soil that is deposited on the cavity walls, so that cleaning gets simpler without need to use chemicals and abrasive means.

# INSTRUCTIONS FOR USE

## – Setting the cooking function

1- Choose the cooking function

2- Set the cooking temperature

3- Set the cooking time and the programmed start

Light (on or off)

Home (Return to home page)

2a - There are three options for setting the temperature:

- Scrolling the bar
- With + or -
- With the knob (if present)

2b - Confirm the selection (option: confirm by pushing the knob)

3a - Set the cooking time

3b - Shows the end of the cooking time

3c - Set the start time

3d - Confirm the setting

# INSTRUCTIONS FOR USE

## – Cooking process

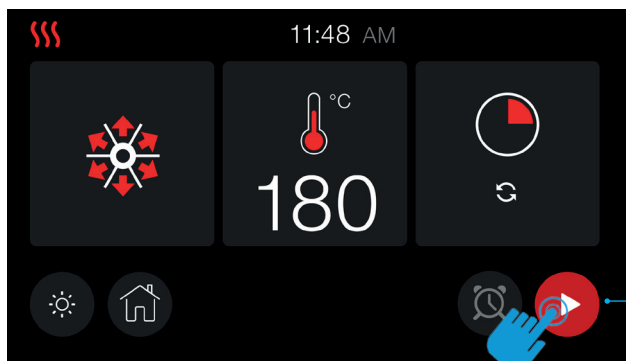

### CAVITY SET

Once the cavity has been set (cooking function, temperature and timer), confirm to start the preheating. At this point the display will switch to the preheating mode

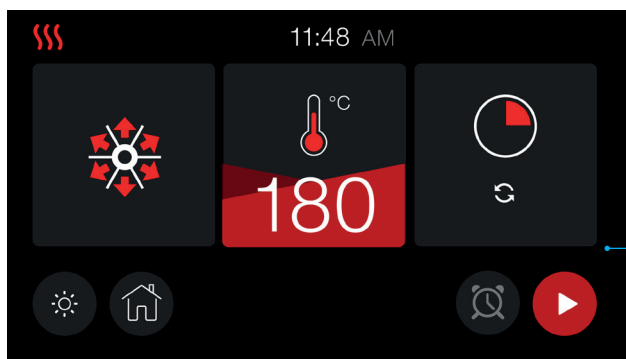

### PREHEATING PHASE

There are four levels that allow you to monitor the preheating process. The red part will gradually increase to fill the display.

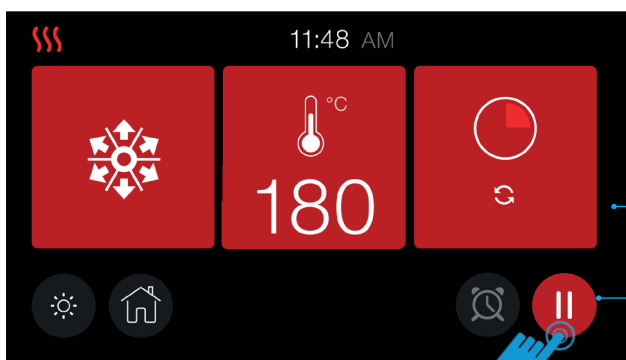

### END OF PREHEATING

When the set temperature is reached, the display will turn red to indicate the end of the preheating phase, and the start of the cooking phase. If a cooking time has been set, the oven will start the count-down and automatically switch off at the end.

In case of no set cooking time it is possible to suspend the cooking touching the pause button



and then finish it using the stop button

(the display will turn grey as at the beginning)



When using the temperature probe the setting range is shown below, and the heating ends when the temperature value set for the probe is reached.

**ATTENTION: use only the temperature probe recommended for this oven**

### PROBE TEMPERATURE SELECTOR

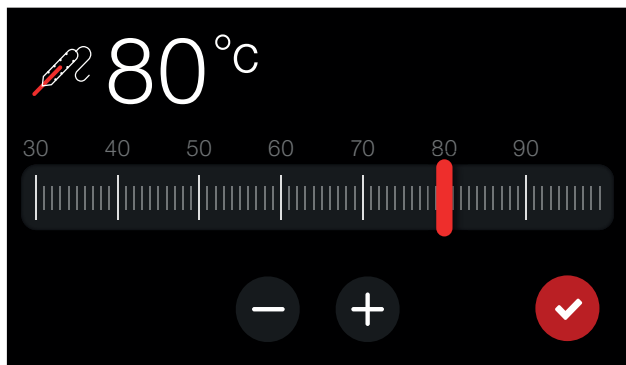

### PREHEATING MODE WITH MEAT PROBE

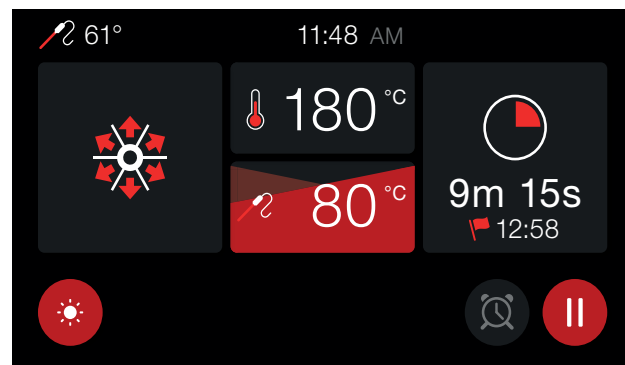



# INSTRUCTIONS FOR USE

## – Cooking function setting

### Microwave operation

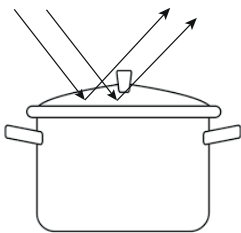
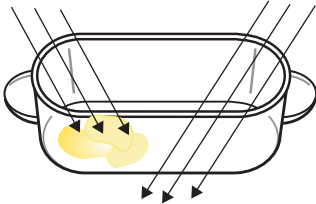

### How it works

In the oven there is a high-frequency tube (magnetron) that converts electrical energy into microwaves. These are distributed evenly throughout the oven interior, and are reflected by the metal sides of the oven interior. In order for microwaves to reach the food, they must be able to pass through the cooking utensil being used. All food contains moisture molecules which, when subjected to microwave energy, start to oscillate at high frequency. The friction caused by this vibration creates heat, which first starts developing around the outside of the food and then slowly penetrates towards the centre. The heat is generated in the food itself.

Microwaves can penetrate porcelain, glass, cardboard and plastics, but not metal. Do not, therefore, use utensils made of metal, or which contain metal, for example in the form of gold or silver trim. The metal reflects the microwaves and this could cause sparking. The microwaves cannot be absorbed. However, the accessories and racks supplied with the oven can be used in all operating modes, including microwaves: it is important not to put metal containers in contact with these accessories.

### Advantages

Food can generally be cooked without adding much liquid or oil and grease. Microwaves stop being produced as soon as the cooking process is interrupted or the appliance door is opened. When the appliance is in operation, the closed door prevents microwaves escaping from the appliance.

### Useful hints

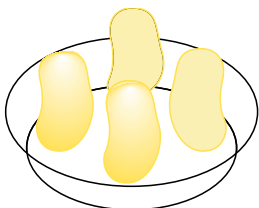
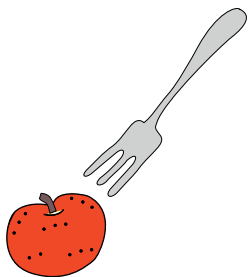

### General:

After you switch off the appliance, let the food stand for some minutes (refer to "Microwave Tables: standing time").

Remove the aluminium foil packaging, metal containers, etc. before you prepare the food.

### Cooking:

If possible, cook food covered with material suitable for use in the microwave. Only cook food without a cover if you want to keep a crust.

Do not overcook the dishes by setting the power and time too high. The food can dry out, burn or catch fire in some places.

Do not use the appliance to cook eggs in their shells and snails, because they can burst. With fried eggs, pierce the yolks first.

Prick food with "skin" or "peel", such as potatoes, tomatoes, sausages, with a fork several times before cooking so that the food does not burst.

For chilled or frozen food, set a longer cooking time.

Dishes which contain sauce must be stirred from time to time.

Vegetables that have a firm structure, such as carrots, peas or cauliflower, must be cooked in water.

Turn larger pieces after half the cooking time.

If possible, cut vegetables into similar sized pieces. If you are cooking a number of portions of the same type of food (eg. boiled potatoes), arrange the portions in a ring around the outside of an ovenproof dish to ensure they cook evenly.

Use flat, wide dishes.

Do not use cookware made of porcelain, ceramic or earthenware with small holes, e. g. on handles or unglazed bottoms. Moisture going into the holes can cause the cookware to crack when it is heated.

### Defrosting meat, poultry, fish:

Put the frozen, unwrapped food on a small upturned plate with a container below it, or on a defrosting rack or plastic sieve so that the defrosting liquid can run off.

Turn the food after half the defrosting time. If possible, divide and then remove the pieces that have started to defrost.

# INSTRUCTIONS FOR USE

## – Cookware / Material

	Microwave			Oven/Grill
	Defrosting	Heating	Cooking	
• Ovenproof glass and porcelain (with no metal components, e. g. Pyrex, heat-proof glass)	•	•	•	•
• Non-ovenproof glass and porcelain 1)	•	--	--	--
• Glass and glass ceramic made of ovenproof/frost-proof material (e. g. Arcoflam), grill shelf	•	•	•	•
• Ceramic 2), earthenware 2)	•	•	•	--
• Heat-resistant plastic up to 200 °C 3)	•	•	•	--
• Cardboard, paper	•	--	--	--
• Clingfilm	•	--	--	--
• Roasting film with microwave safe-closure 3)	•	•	•	--
• Roasting dishes made of metal, e. g. enamel, cast iron	--	--	--	•
• Baking tins, black lacquer or silicon-coated 3)	--	--	--	•
• Baking tray	•	•	•	•
• Ready meals in packaging 3)	•	•	•	•

### Ready meals:

Ready meals in metal packaging or plastic trays with metal covers can only be defrosted or heated in the microwave if they are expressly designated as suitable for use in the microwave.

You must follow the manufacturer's instructions printed on the packaging (e. g. remove the metal cover and pierce the plastic film).

1. With no silver, gold, platinum or metal plating/decorations
2. Without quartz or metal components, or glazes which contain metals
3. You must follow the manufacturer's instructions

# INSTRUCTIONS FOR USE

## – Steam cooking

### Advantages

The steam oven has many advantages, it allows to cook in a healthy and savoury way. Food is cooked by the moist heat generated by the hot water. This means that the cooking process happens at not very high temperatures, so that minerals and vitamins inside the food are not altered. With this process the taste and flavour of every food are perfectly maintained. One important feature is that it is possible to avoid using oils or grease for cooking: for this reason steam is the best method to prepare vegetables and fish, because all nutritional characteristics are preserved. On the other hand, steam is less suited for cooking meat. To be well done meat needs higher temperatures in order to avoid dispersing the internal juices.

### Operation

To cook with steam it is necessary to fill the tank at least to the first segments indicating the minimum water quantity. Push on the drawer on the right side of the control panel, so that it is ejected slightly; then pull it out until the stop. Pour in the water using the jug supplied and look at the icon on the display. When opening the drawer the display shows:

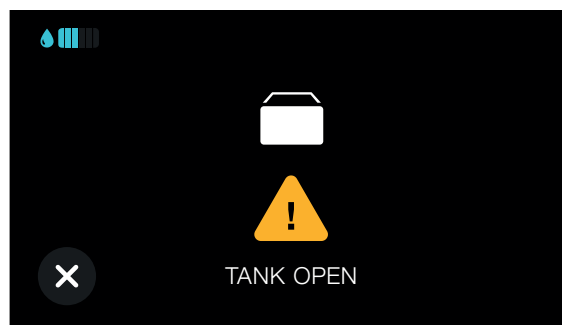

At the same time also the segments relevant to the water level will light up. **Only use cold tap water; never use filtered (demineralised) or distilled water, mineral water or other liquids.**

### WARNING!

- Do not pour water directly inside the boiler in the bottom side of the oven cavity.
- Do not pour flammable or alcoholic liquids into the water tank.
- During tank filling, with the water level increasing, the level indicating segments light up sequentially; minimum, medium and finally maximum. When the maximum is reached, an acoustic signal is emitted.
- **DO NOT POUR ADDITIONAL WATER AFTER THE OVEN HAS SIGNALLED THAT THE TANK IS FULL.**
- **WATER IN EXCESS IS DIRECTLY DUCTED INTO THE OVEN CAVITY AND, FROM THERE, OUTSIDE THE APPLIANCE.**
- Remove water from the cavity using a sponge or a cloth.
- After filling the tank push in the drawer until the latch that holds it closed operates: check that the wording on the display has disappeared.

# CLEANING - CARE - MAINTENANCE

## – Cleaning

### WARNING!

Please refer to the paragraphs about safety.

- Clean the front side of the appliance using a soft cloth soaked in soapy warm water.
- To clean metallic surfaces use a normal detergent.
- Clean the inside of the oven after every usage. In this way it is possible to remove dirt and stains more easily.
- Remove stubborn dirt using special oven cleaners.
- After every usage clean the oven accessories and let them dry accurately. Use a soft cloth soaked in soapy warm water.

### Stainless steel parts

- Clean the oven door only with a wet sponge.
- Dry it using a soft cloth.
- Avoid the used of steel wool, acids or abrasive products that could damage the oven surface.
- clean the control panel using the same precautions.

### Cleaning the door gasket

- Regularly check the door gasket. It is located around the opening of the oven cavity.
  - Do not operate the appliance if the door gasket is damaged.
  - Contact an authorised service centre.
- To clean the door gasket please refer to the general instructions about cleaning.

### Steam cleaning cycle

- This procedure used steam to make the removal of food and grease residues from the oven easier.
  1. Select the function - **Steam Cleaning**.
  2. Fill the tank with the jug supplied.
  3. The preset cycle temperature will be 90°C and the duration is 30".
  4. At the end of the cleaning cycle let the appliance cool down.
  5. Once cooled, clean the internal surfaces with a cloth.

1



# CLEANING - CARE - MAINTENANCE

## – Cleaning

---

2

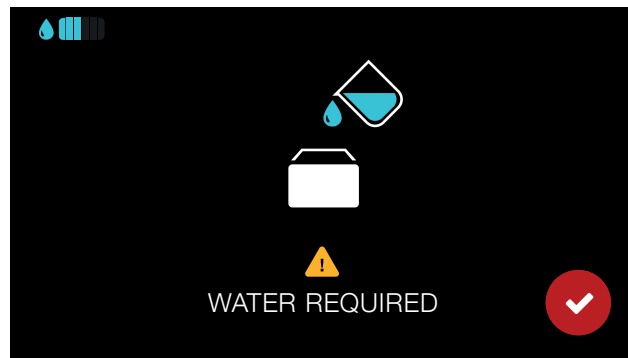

4

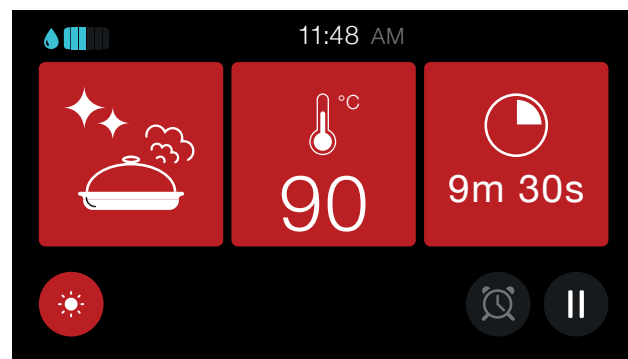

5



# CLEANING - CARE - MAINTENANCE

## – Emptying and Washing the tank

---

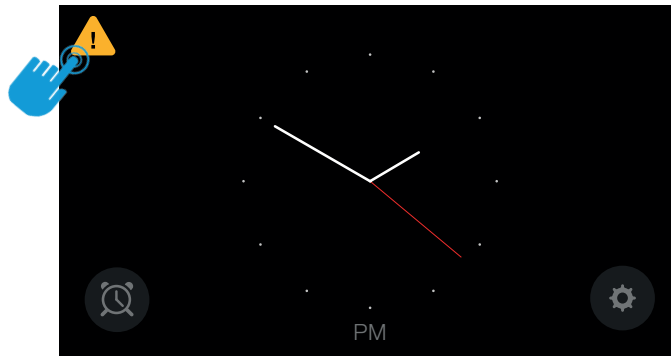

At first power on, a yellow warning triangle appears on the display. Opening the door and touching it, the display shows the message:

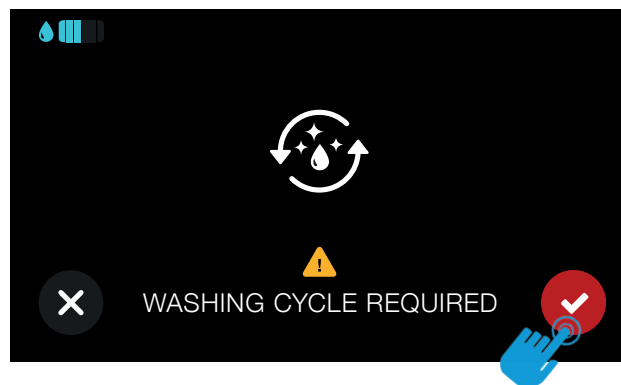

If you do not want to perform the washing cycle, touching the X button makes the triangle disappear; it will be possible to perform the washing selecting the relevant button after opening the settings menu. If you want to proceed with the washing push the confirmation button and the display will show:

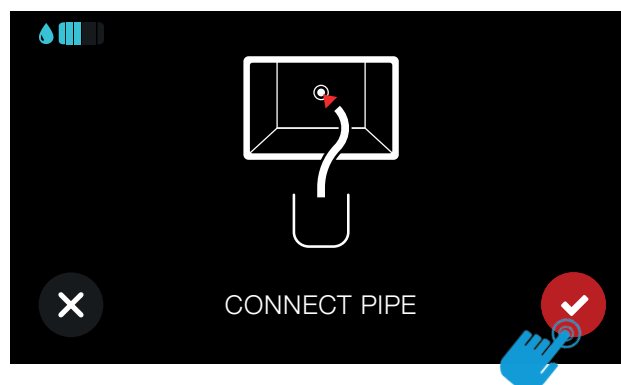

Next insert the silicon tube (included with the accessories) onto the metal nozzle protruding from the back wall of the cooking cavity under the perforated area. Insert the other end of the tube into a container having at least 1L capacity (e.g. the jug supplied in the oven). Then push the confirmation button (the pump begins to operate and starts the emptying).

# CLEANING - CARE - MAINTENANCE

## – Emptying and Washing the tank



When the tank is empty the display prompts to load the descaling solution (5% citric acid, or a package of a descaling product for coffee machine or steam iron) for a complete cleaning use 1L of solution.

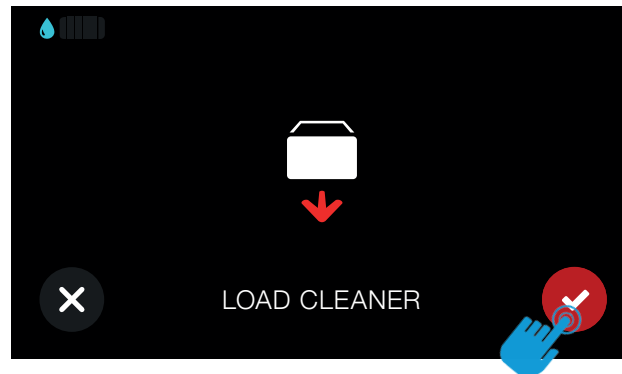

Opening the drawer and confirming the picture becomes:

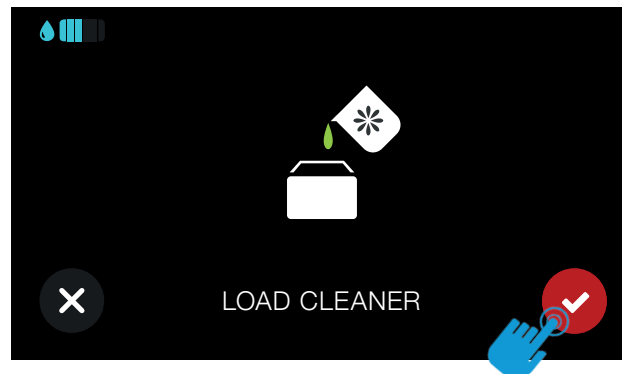

Pushing the confirmation the pump is restarted and the washing of tank and water circuit is performed. When the tank is empty it is necessary to rinse with water (1L again). The display shows:

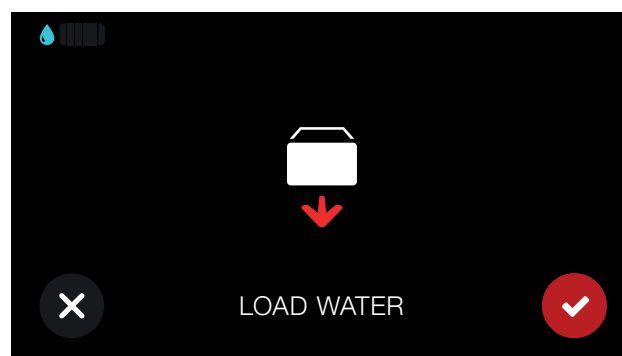

# CLEANING - CARE - MAINTENANCE

## – Emptying and Washing the tank

Opening again the drawer and confirming, the display shows:

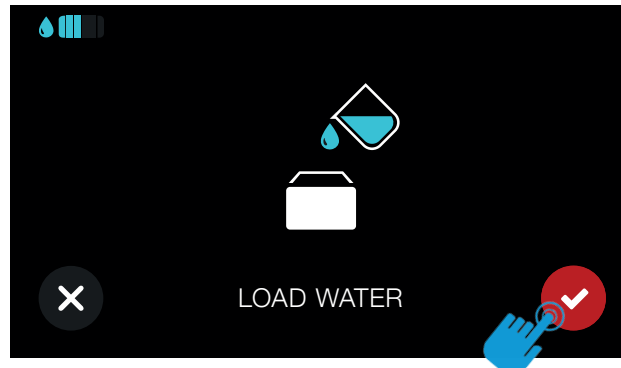

Completely fill the tank and confirm to start the pump and begin the final emptying operation. At the end (the process will take about 10 minutes) the display shows:



When the washing has ended, pushing the confirmation button, it will be possible to start using the appliance normally.  
The washing and emptying cycles can be performed at any moment by entering the relevant menu pushing the settings button (see pag. 23)

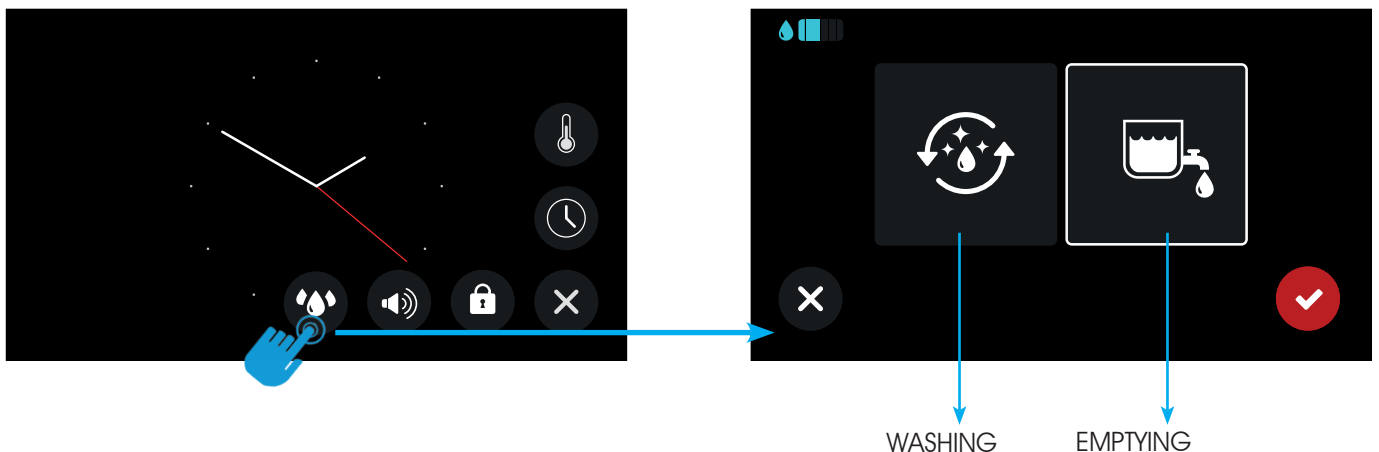



# CLEANING - CARE - MAINTENANCE

## – Emptying and Washing the tank

Meaning of warnings relevant to the water circuit



This warning appears every time the oven is connected to the mains supply. It is only informative and allows to normally operate the appliance even if the washing is not performed.

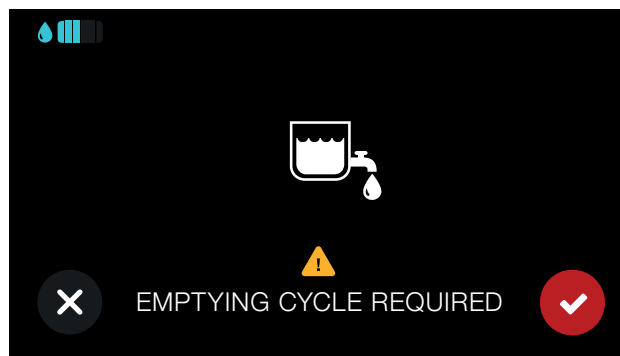

This warning appears 7 days after the last filling of the tank and invites to empty it to avoid deterioration of the water quality. It is only informative and allows to normally operate the appliance even if the emptying is not performed. However it is recommended to empty the tank after every cooking cycle in order to begin the next cooking with a fresh water load



This warning appears after the boiler has worked for 80 hours (steam and modes combined with steam). From this moment it will be possible to perform only 10 more cooking cycles with steam: then, if the washing is not performed, the operation modes with steam can be selected but, when trying to start them, an error message will be displayed and the cooking will not begin.

# PROBLEM SOLVING

## – Error messages

### System errors

The following errors are detected:  
The error code syntax is: "E YY X", where:

YY = error code  
x = cavity number when error occurred or '0' for general errors

Description	Error ID
Cavity probe in open circuit	00
Cavity probe in short circuit	01
Boiler probe in open circuit	02
Boiler probe in short circuit	03
Meat probe in open circuit	04
Meat probe in short circuit	05
Overheating	08
Boiler not heating	09
Pump not operating	10
Emptying error	14
Washing needed	15
Tangential fan not working	16
Communication error	20

### ERROR MESSAGE

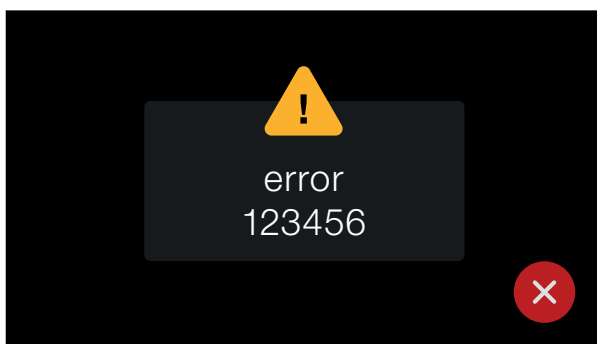

In case of error disconnect and reconnect the appliance.  
If the error is present again you will need the intervention of an authorized technician

### DOOR OPEN MESSAGE (DURING OPERATION)

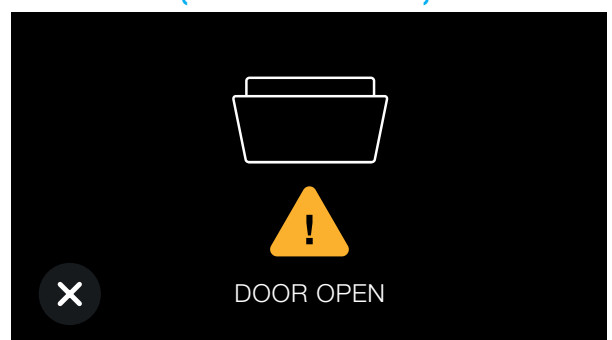

Close the oven door.

